



CS-109

Mini Tower Case

formulav-line.com

Front I/O Cable Connection

Front I/O Connectors

(Please refer to the motherboard's manual for further instructions).

Note: Specifications may vary depending on your region. Contact your local retailer for more information.

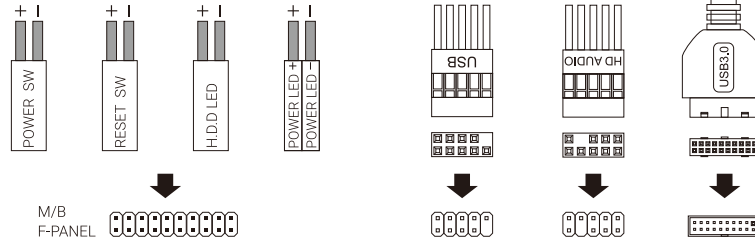

Accessory Bag Contents

- 1 x14
- 2 x5
- 3 x6
- 4 x2
- 5 x2
- 6 x2

How to Install Guide

(1) Install Motherboard

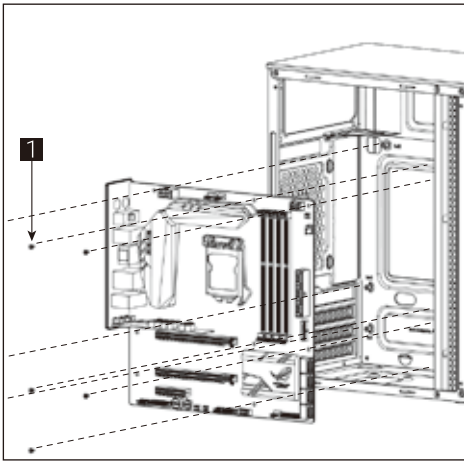

- English**
Install Motherboard
- Español**
Instalación de Placa madre
- Deutsche**
Lüfter installieren
- Français**
Installer carte mère
- Italiano**
Installazione della scheda madre
- Polski**
Instalacja płyty głównej
- Русский**
Установите материнскую плату
- Português**
Instalar a placa principal
- 繁體中/簡中**
安裝主機板/安裝主機板
- 日本語**
マザーボードを取り付けます
- Қазақ тілі**
Аналық тақтаны орнатыңыз
- Türkçe**
Anakart yükleyin

(2) Install PSU

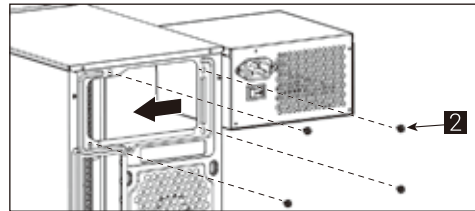

- English**
Install PSU
- Español**
Instalación de Fuente
- Deutsche**
Netzteil installieren
- Français**
Installer unité d'alimentation

- Italiano**
Installazione della PSU
- Polski**
Instalacja zasilacza
- Русский**
Установите блок питания
- Português**
Instalar a fonte de alimentação

- 繁體中/簡中**
安裝電源供應器/安裝電源供應器
- 日本語**
PSUを取り付けます
- Қазақ тілі**
Қорек блогын орнатыңыз
- Türkçe**
PSU yükleyin

(3) Install Add-on Card

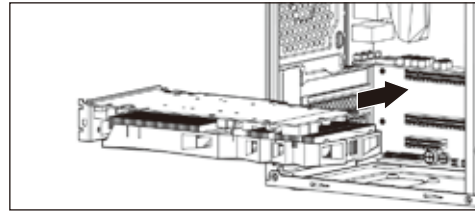

- English**
Install add-on Card
- Español**
Inserte la tarjeta add-on
- Deutsche**
Setzen Sie die Erweiterungskarte ein
- Français**
Insérez la carte d'extension

- Italiano**
Inserire la scheda aggiuntiva
- Polski**
Włóż dodatkową kartę
- Русский**
Установите плату расширения
- Português**
Insira a placa suplementar

- 繁體中/簡中**
安裝擴充卡/安裝擴充卡
- 日本語**
ドオンカードを挿入します
- Қазақ тілі**
Кеңейту тақшасын салыңыз
- Türkçe**
Eklenti Yükleme Kartı

(4a) Install 3.5" HDD x1

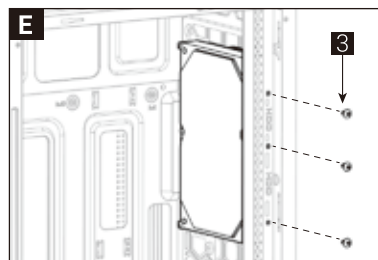
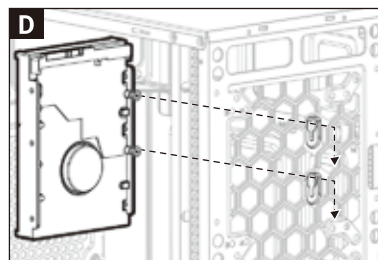
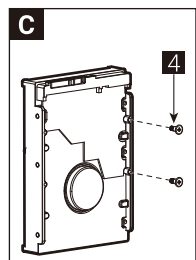
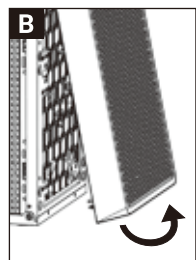
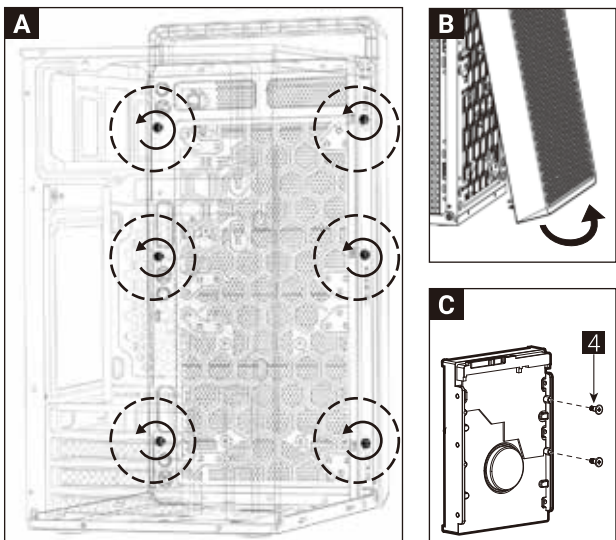

(4b) Install 3.5" HDD x1

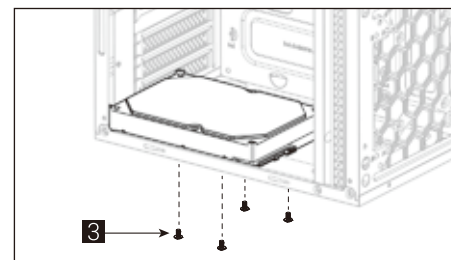

- English**
Install 3.5" HDD
- Español**
Instalación de 3.5" HDD
- Deutsche**
3,5-Zoll-Festplatte installieren
- Français**
Installer disque dur 3,5"
- Italiano**
Installare l'unità HDD 3,5"
- Polski**
Instalacja HDD 3,5"
- Русский**
Установите 3.5" жесткий диск
- Português**
Instalar o HDD de 3.5"
- 繁體中/簡中**
安裝3.5" 硬碟/安裝3.5" 硬碟
- 日本語**
3.5インチHDDを取り付けます
- Қазақ тілі**
3.5 «қатты дискіні» орнатыңыз
- Türkçe**
Yükleme 3.5 "HDD

(5a) Install 2.5" SSD x1

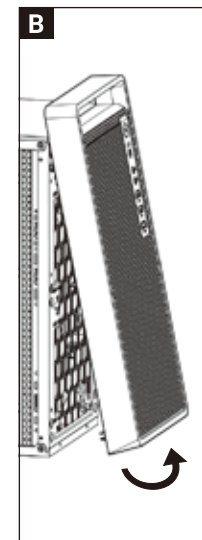
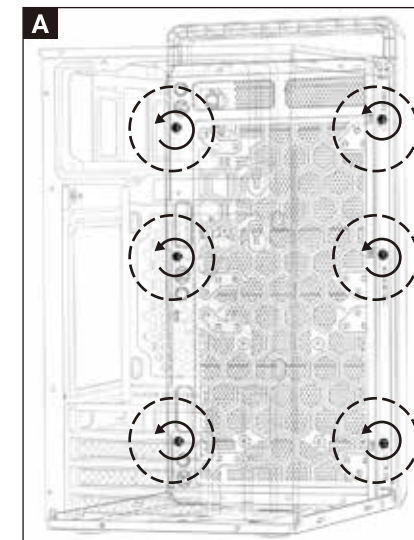

(5b) Install 2.5" SSD x1

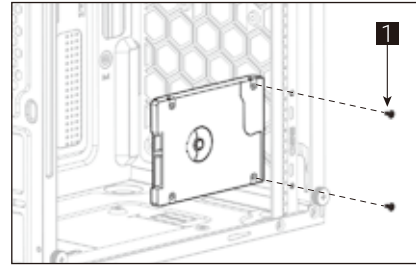
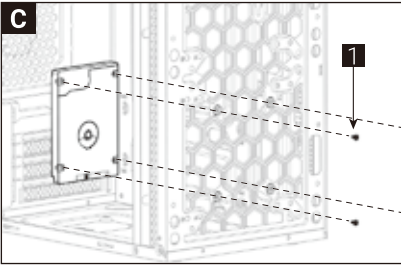

(5c) Install 2.5" SSD x1

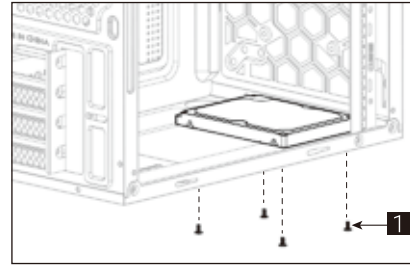

(5d) Install 2.5" SSD x1

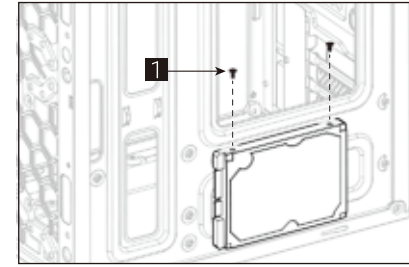

English
Install 2.5" SSD
Español
Instalación de 2.5" SSD
Deutsche
2.5-Zoll-SSD installieren
Français
Installer SSD 2,5"
Italiano
Installare l'unità SSD 2,5"
Polski
Instalacja SSD 2,5"

Русский
Установите 2.5" жесткий диск
Português
Instalar o SSD de 2,5"
繁體中文
安裝 2.5" 硬碟/安裝 2.5" 硬碟
日本語
2.5インチSSDを取り付けます
Қазақ тілі
2.5 «қатты дискіні» орнатыңыз
Türkçe
Yüklemeye 2.5" SSD

(6a) Install Front Fans

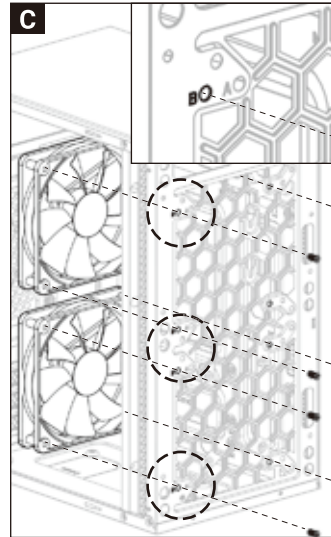
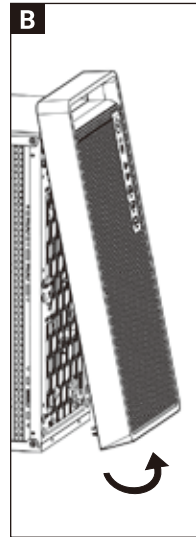
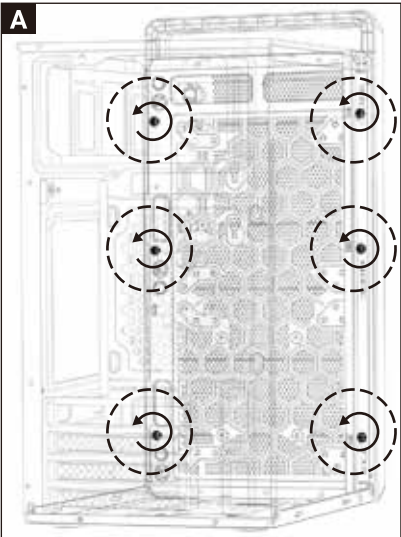

(6b) Install Rear Fan

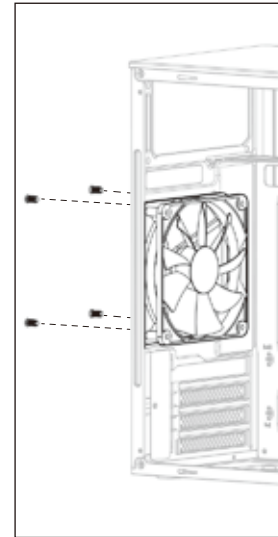

English
Install Fan
Español
Instalación de Ventilador
Deutsche
Lüfter installieren
Français
Installer ventilateur
Italiano
Installazione della ventola
Polski
Instalacja wentylatora
Русский
Установите вентилятор
Português
Instalar as ventoinhas
繁體中文
安裝機箱風扇/安裝機箱風扇
日本語
ファンを取り付けます
Қазақ тілі
Желдеткіш орнатыңыз
Türkçe
Fan yükleyin

(7a) Install Front Radiator

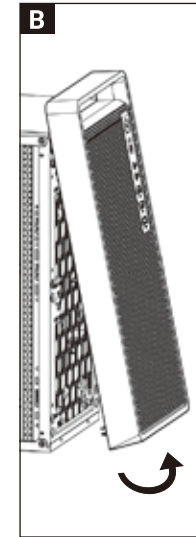
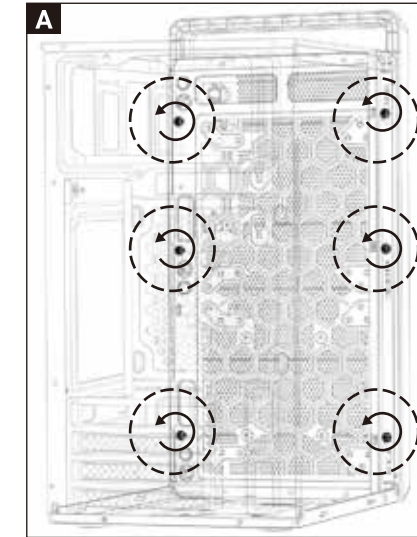

(7b) Install Rear Radiator

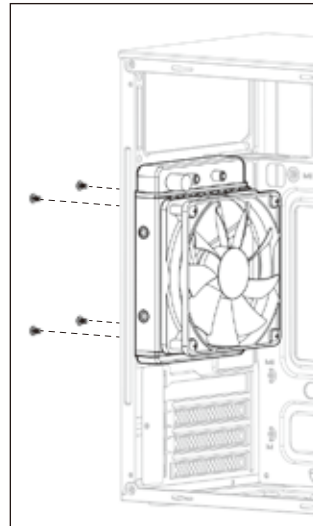
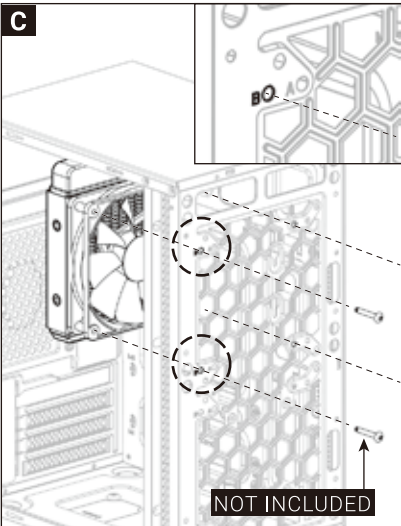

English
Install the radiator
Español
Instalar radiador
Deutsche
Lüfter einbauen
Français
Installer le radiateur
Italiano
Installare radiatore
Polski
Zainstaluj chłodnicę
Русский
Установите радиатор
Português
Instalar o radiador
繁體中文
安裝散熱排/安裝散熱排
日本語
ラジエーターの取り付け
Қазақ тілі
радиаторды орнатыңыз
Türkçe
radyatör takın

I/O Panel

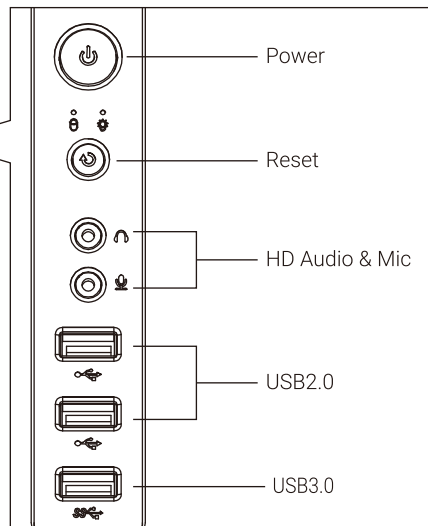
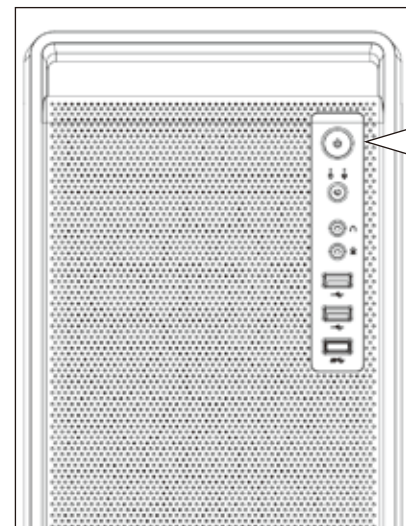

Note:
Specifications may vary depending on your region.
Contact your local retailer for more information.